

E5 Mini 蓝牙音箱  
Bluetooth Speaker

使用说明书  
USER MANUAL

## **Table of Contents**

01 - 07 English

08 - 14 简体中文

# 01 Precautions

English

- ◆ Please read the instruction first.
- ◆ Please follow the instruction carefully.
- ◆ Please store and use this product at normal temperature.
- ◆ Do not use this product near heat sources such as radiators, heat registers, stoves, or other apparatus (including amplifiers) that produce heat.
- ◆ Do not block the opening of the speaker, and do not insert objects into the vents or slots of the speaker.
- ◆ Do not throw and drop the product to avoid damages.
- ◆ Please charge the speaker with product rated voltage.
- ◆ If the connection line does not match your device, please contact the dealer.
- ◆ Please keep volumes of the speaker mode rate to avoid temporary or permanent hearing impairment.
- ◆ No matter the equipment is damaged due to any reason, it must be repaired by professional maintenance personnel in time. Unauthorized disassembly will invalidate the warranty.
- ◆ If the battery is not properly replaced, there will be an explosion accident, which can only be replaced with the same type of battery.
- ◆ Do not disassemble, impact, squeeze or throw in to fire; If severe swelling occurs, do not continue to use; Do not place in a high temperature environment, do not use after the battery is soaked in water.
- ◆ Battery (battery pack or combined battery) can not be exposed to such conditions as sunshine, fire or similar over heating conditions.
- ◆ If consumers use a power adapter to charge, they should purchase a supporting power adapter that has obtained CCC certification and meets the standard requirements.

## 02 Packing list

English

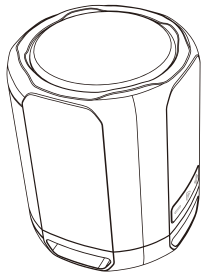

1\* Bluetooth Speaker

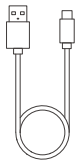

1\*USB Type-C Charging Cable



1\*Lanyard



1\*User Manual

## 03 Button Function

English

### Short Press:

Decrease volume

### Long Press:

Play previous song

### Play / Pause:

Short press to pause / play music.

### Short Press:

Increase volume

### Long Press:

**Power Key:** Press and hold 2 seconds to power on/off.

**Reset Key:** No respond if any operation, press and hold the power button for 8 seconds to reset the speaker.”

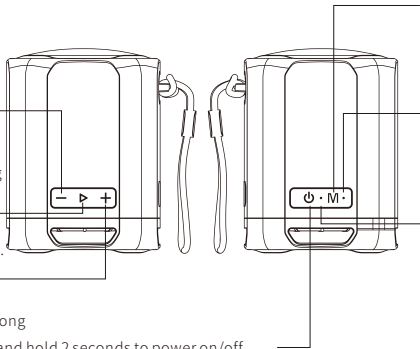

**Mode switch:** short press to switch Bluetooth mode/TF card mode

**Remark:**Power on,default is Bluetooth mode

**Bluetooth disconnection:** Press and hold 2 seconds to Bluetooth disconnection,Bluetooth is discoverable

### LED indicator

Blue light flashes, waiting for Bluetooth pairing.

After paired successfully, the blue light will stay on

### Power LED indicator

Red light stays on while charging. Full charged, green light stays on.

Battery indication:

Red light flashes slowly<10%

10%<=Red light <20%

20%<=Orange light<55%

55%<=Yellow light<75%

Green light>=75%

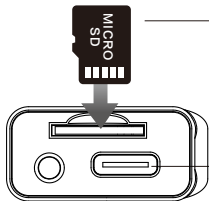

### Micro SD playback

Power on ,Insert a Micro SD card into the card slot,there will be a voice prompt, and the speaker will automatically play music stored in the Micro SD card

### Charging

Connect Type-C power adapter with DC5V~1A or a computer for charging

### Data access

Power on ,Insert a Micro SD card into the card slot, pause the music playback, connect the computer with a data cable, the speaker will come to the card reader mode automatically,and then you can copy the music files and store them on the Micro SD card.

## 05 Bluetooth Connection

English

### 1, Turn on the speaker:

Long press "Power key" 2 seconds to turn on bluetooth, there will be both voice prompt and indication light flashing, waiting form bluetooth paring

### 2, Connect the device

Search Bluetooth function on your mobile device or computer. Find the E5 Mini on the Bluetooth device and connect it. After successful Bluetooth connection, there will be voice prompt and indication light staying on

Next time the speaker will reconnect to the last paired device automatically once your device' s Bluetooth is turned on.

### Bluetooth disconnection

Press and hold "M" button to disconnect current device and set E5 Mini into discoverable status;

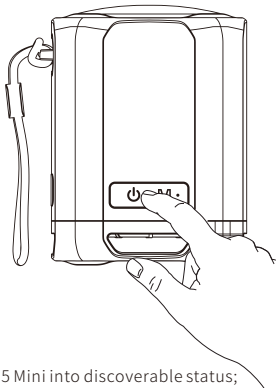

## 06 True Wireless Stereo Function

English

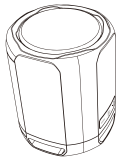

Master Speaker

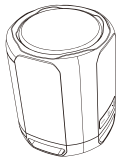

Slave Speaker

### 1, Master speaker TWS Connection launching

Turn on and choose any one of them for master speaker ,power on and switch to bluetooth mode,press both "Volumn +" and "Volumn -" together,the speaker will enter TWS connecting mode, searching the slave speaker

### 2, Slave TWS connection

Turn on another speaker and switch to Bluetooth mode,waiting for TWS connection

3,There will be a voice prompt after TWS is connected successfully.

### 4,TWS disconnection

After TWS connection,if need exit the TWS mode,just press both "Volumn +" and "Volumn -" together.

### Other tips:

01, Master speaker is left channel. Slave speaker is right channel.

02, The TWS system only supports two speakers.

03, When TWS paired successfully, both speakers will have the same functions simultaneously.



## 07 Technical Parameters

English

Basic	
Type	Bluetooth Speaker
Storage type	Micro SD card Supports up to 32GB
Power Supply	DC5V/1A Type-C charging cable Charging time: around 2.5 hours
Technical	
Trumpet	52mm full frequency trumpet + Low frequency radiator
Frequency Response	100Hz-20KHZ
BT Version	Bluetooth 5.3
Music Files support	
Format Support	MP3:8Kbps-320Kbps WMA:32Kbps-384Kbps WAV:32Kbps-1414Kbps

**Product Size:** 76 × 76 × 100mm

**Product weight:** 376g (Including built-in Lithium battery)

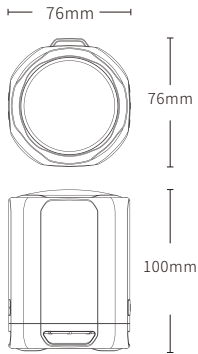

## 08 注意事项

简体中文

- ◆请阅读本说明。
- ◆请遵循本说明。
- ◆请在常温环境中存放和使用本产品。
- ◆请勿在近热源处使用本产品，如散热器、热风调节器、炉灶或其他产生热量的仪器（包括放大器）。
- ◆请勿堵塞音箱的开口处，勿将物体塞入音箱的通风口或槽隙中。
- ◆请勿丢弃，避免因跌落造成本产品损坏。
- ◆请使用音箱额定电压的电源充电器充电。
- ◆如果连接线与您的设备不匹配，请与销售商联系。
- ◆请将音箱调至合适音量，避免对您的听力造成损害。
- ◆无论设备因何原因损坏，都必须及时请专业维修人员修理，擅自拆卸将使保修失效。
- ◆如果电池更换不当会有爆炸危险，只能用同样类型或等效类型的电池来更换。
- ◆禁止拆解、撞击、挤压或投入火中；若出现严重鼓胀，请勿继续使用；请勿置于高温环境中，电池浸水后禁止使用。
- ◆电池（电池包或组合电池）不得暴露在诸如日照、火烤或类似过热环境中。
- ◆消费者若使用电源适配器充电，则应购买配套使用获得CCC认证并满足标准要求的电源适配器。

## 09 包装清单

简体中文

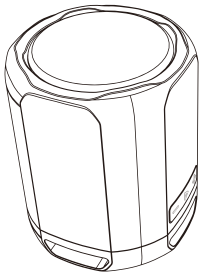

音箱主机 1台

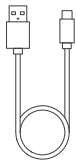

USB电源线/数据线 1条



挂绳 1条



使用指南 1份

## 10 按键功能指示

简体中文

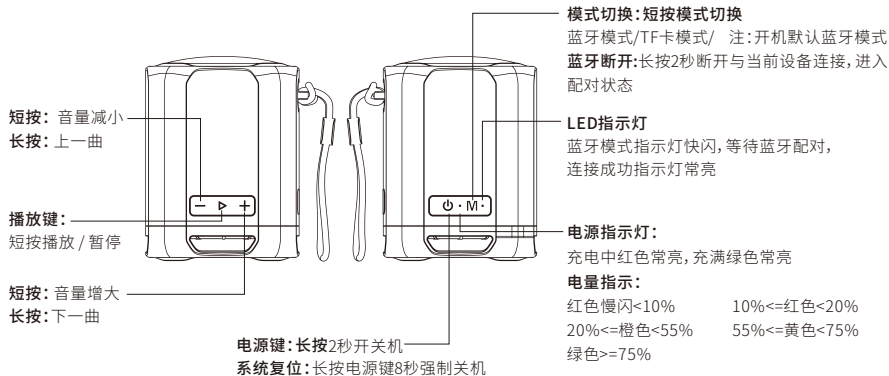

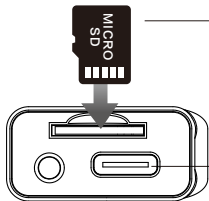

### Micro SD播放

音箱开机状态插入Micro SD卡，提示音响起，音箱将自动播放Micro SD卡内的音乐文件

### 电源充电

连接DC5V~1A以上的USB电源适配器，或电脑USB端口充电

### 数据传输

开机状态下，音箱内已插入Micro SD卡，音乐暂停播放，数据线连接电脑，音箱自动进入读卡器模式，即可拷贝音乐文件存入Micro Sd存储卡。

## 12 蓝牙音频连接

简体中文

### 1、音箱开机

长按电源键2秒开机，开机提示音响起后，接着提示音响起指示灯闪烁，等待蓝牙配对。

### 2、连接到移动设备

开启移动设备蓝牙选项，在蓝牙设备列表中找到E5 Mini，连接成功您将听到提示音，同时LED指示灯常亮。

后续使用中，只要保持移动设备的蓝牙开启，即可自动连接。

**蓝牙断开:**长按2秒M键断开与当前设备连接，进入配对状态，等待连接

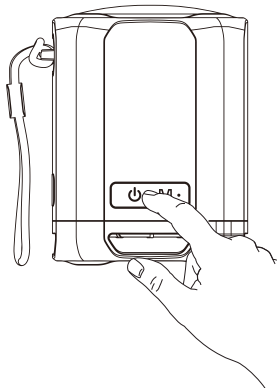

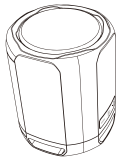

主音箱

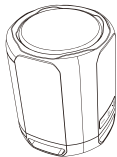

从音箱

### 1、主机TWS发起连接

选中一台音箱开机并切换到蓝牙模式，同时短按“音量+ -”键，听到提示音后，音箱进入TWS串联模式，开始主动去搜索从机。

### 2、从机TWS连接

从机音箱开机并切换到蓝牙模式，等待TWS主机连接。

### 3、TWS连接成功

稍后主从机连接成功，并播报提示音，主机M键指示灯正常指示蓝牙模式状态，从机M键指示灯蓝灯常亮。

### 4、TWS断开操作

连接成功后，如需要退出TWS模式，同时短按“音量+ -”键 即可退出。

### 其它说明：

01、主机为左声道，从音箱为右声道。

02、TWS无线串联，仅支持2个音箱设备无线串联。

03、无线串联成功后，操作任意一音箱功能按键，另一音箱同步相应操作。

## 14 技术参数

简体中文

基本参数	
音箱类型	蓝牙音箱
存储类型	支持FAT/FAT32格式 Micro SD卡
电源供应	DC5V-1A的USB电源 充电约2.5小时左右
技术参数	
扬声器单元	52mm全频喇叭+ 低频辐射器
频率响应	100Hz-20KHZ
无线连接	Bluetooth 5.3
USB规格	USB2.0、兼容USB1.1
播放功能	
文件格式	MP3:8Kbps-320Kbps WMA:32Kbps-384Kbps WAV:32Kbps-1414Kbps

产品规格:76×76×100mm

产品净重:376g(含内置锂电池)

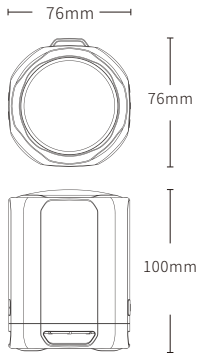





自助售后服务



不见不散公众号

**生产企业:深圳市不见不散电子有限公司**

地 址: 深圳市宝安区航空路32号-不见不散视听创新园

电 话: 0755-61181399 网 址: [www.hb2099.com](http://www.hb2099.com)